

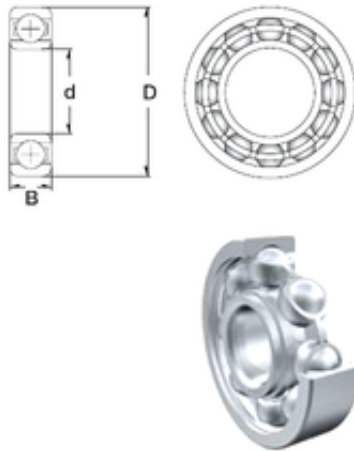

KFY MANUFACTURING MEXICO LIMITED



6,35 mm x 9,525 mm x 3,175 mm ZEN
R168-2TS deep groove ball bearings

Bearing No. R168-2TS

Size	6.35x9.525x3.175 mm
Bore Diameter	6,35 mm
Outer Diameter	9,525 mm
Width	3,175 mm
d	6,35 mm
D	9,525 mm
B	3,175 mm
C	3,175 mm
Basic dynamic load rating (C)	0,373 kN
Basic static load rating (C0)	0,172 kN
(Grease) Lubrication Speed	48000 r/min

R168-2TS Bearing 2D drawings and 3D CAD models