

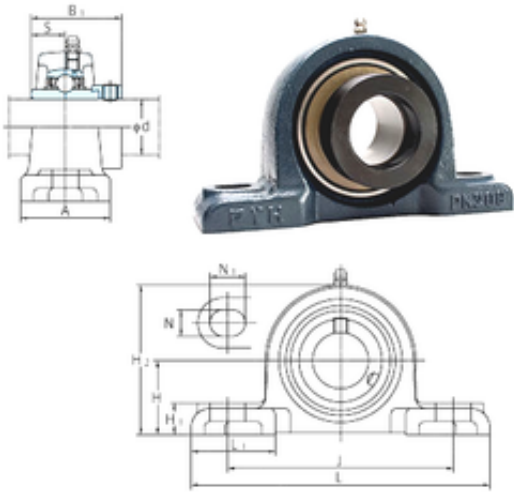

KFY MANUFACTURING MEXICO LIMITED



FYH NAPK201-8 bearing units

Bearing No. NAPK201-8

Bore Diameter	12,7 mm
d	12,7 mm
H	31,8 mm
A	41 mm
B1	43,7 mm
H1	14 mm
H2	63 mm
J	98 mm
L	133 mm
L1	45 mm
N	11 mm
N1	14 mm
S	17,1 mm
Bolt (G)	3/8
Weight	0,82 Kg
Basic dynamic load rating (C)	12,8 kN
Basic static load rating (C0)	6,65 kN

NAPK201-8 Bearing 2D drawings and 3D CAD models