

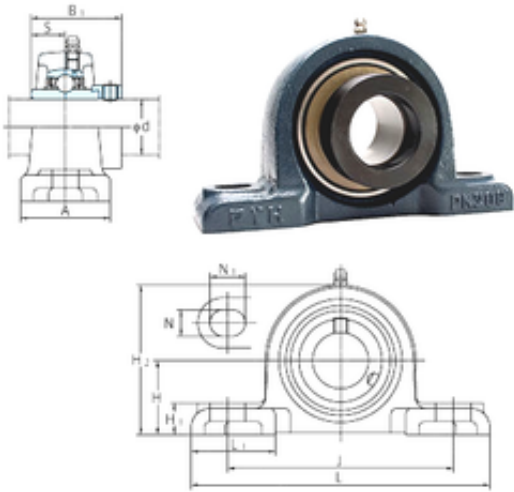

KFY MANUFACTURING MEXICO LIMITED



FYH NAPK209-26 bearing units

Bearing No. NAPK209-26

Bore Diameter	41,275 mm
d	41,275 mm
H	52,4 mm
A	54 mm
B1	56,3 mm
H1	20 mm
H2	106 mm
J	146 mm
L	190 mm
L1	52 mm
N	14 mm
N1	19 mm
S	21,4 mm
Bolt (G)	1/2
Weight	2,7 Kg
Basic dynamic load rating (C)	34,1 kN
Basic static load rating (C0)	21,3 kN

NAPK209-26 Bearing 2D drawings and 3D CAD models