

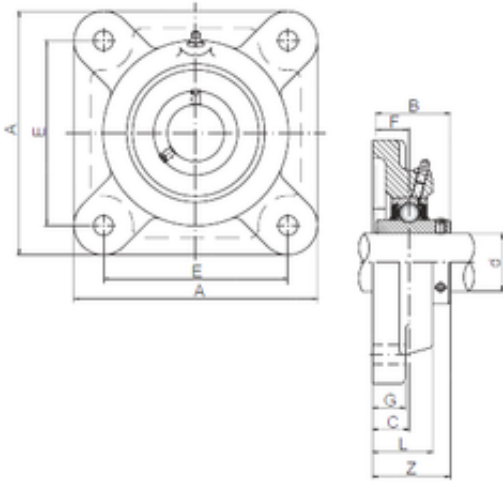

KFY MANUFACTURING MEXICO LIMITED



ISO UCF307 bearing units

Bearing No. UCF307

Bore Diameter	35 mm
Width	48 mm
d	35 mm
Z	49 mm
A	135 mm
B	48 mm
C	20 mm
E	100 mm
F	19 mm
G	16 mm
L	36 mm
S	19 mm
Bolt (G)	M16

UCF307 Bearing 2D drawings and 3D CAD models